

Four-door One-way Access Controller

User's Manual

V1.0.0

Cybersecurity Recommendations

Mandatory actions to be taken towards cybersecurity

1. Change Passwords and Use Strong Passwords:

The number one reason systems get “hacked” is due to having weak or default passwords. It is recommended to change default passwords immediately and choose a strong password whenever possible. A strong password should be made up of at least 8 characters and a combination of special characters, numbers, and upper and lower case letters.

2. Update Firmware

As is standard procedure in the tech-industry, we recommend keeping NVR, DVR, and IP camera firmware up-to-date to ensure the system is current with the latest security patches and fixes.

“Nice to have” recommendations to improve your network security

1. Change Passwords Regularly

Regularly change the credentials to your devices to help ensure that only authorized users are able to access the system.

2. Change Default HTTP and TCP Ports:

- Change default HTTP and TCP ports for systems. These are the two ports used to communicate and to view video feeds remotely.
- These ports can be changed to any set of numbers between 1025-65535. Avoiding the default ports reduces the risk of outsiders being able to guess which ports you are using.

3. Enable HTTPS/SSL:

Set up an SSL Certificate to enable HTTPS. This will encrypt all communication between your devices and recorder.

4. Enable IP Filter:

Enabling your IP filter will prevent everyone, except those with specified IP addresses, from accessing the system.

5. Change ONVIF Password:

On older IP Camera firmware, the ONVIF password does not change when you change the system’s credentials. You will need to either update the camera’s firmware to the latest revision or manually change the ONVIF password.

6. Forward Only Ports You Need:

- Only forward the HTTP and TCP ports that you need to use. Do not forward a huge range of numbers to the device. Do not DMZ the device's IP address.
- You do not need to forward any ports for individual cameras if they are all connected to a recorder on site; just the NVR is needed.

7. Disable Auto-Login on Smart PSS:

Those using Smart PSS to view their system and on a computer that is used by multiple people should disable auto-login. This adds a layer of security to prevent users without the appropriate credentials from accessing the system.

8. Use a Different Username and Password for Smart PSS:

In the event that your social media, bank, email, etc. account is compromised, you would not want someone collecting those passwords and trying them out on your video surveillance system. Using a different username and password for your security system will make it more difficult for someone to guess their way into your system.

9. Limit Features of Guest Accounts:

If your system is set up for multiple users, ensure that each user only has rights to features and functions they need to use to perform their job.

10. UPnP:

- UPnP will automatically try to forward ports in your router or modem. Normally this would be a good thing. However, if your system automatically forwards the ports and you leave the credentials defaulted, you may end up with unwanted visitors.
- If you manually forwarded the HTTP and TCP ports in your router/modem, this feature should be turned off regardless. Disabling UPnP is recommended when the function is not used in real applications.

11. SNMP:

Disable SNMP if you are not using it. If you are using SNMP, you should do so only temporarily, for tracing and testing purposes only.

12. Multicast:

Multicast is used to share video streams between two recorders. Currently there are no known issues involving Multicast, but if you are not using this feature, deactivation can enhance your network security.

13. Check the Log:

If you suspect that someone has gained unauthorized access to your system, you can check the system log. The system log will show you which IP addresses were used to login to your system and what was accessed.

14. Physically Lock Down the Device:

Ideally, you want to prevent any unauthorized physical access to your system. The best way to achieve this is to install the recorder in a lockbox, locking server rack, or in a room that is behind a lock and key.

15. Connect IP Cameras to the PoE Ports on the Back of an NVR:

Cameras connected to the PoE ports on the back of an NVR are isolated from the outside world and cannot be accessed directly.

16. Isolate NVR and IP Camera Network

The network your NVR and IP camera resides on should not be the same network as your public computer network. This will prevent any visitors or unwanted guests from getting access to the same network the security system needs in order to function properly.

Regulatory Information

FCC Information



Changes or modifications not expressly approved by the party responsible for compliance could void the user's authority to operate the equipment.

FCC conditions:

This device complies with part 15 of the FCC Rules. Operation is subject to the following two conditions:

- This device may not cause harmful interference.
- This device must accept any interference received, including interference that may cause undesired operation.

FCC compliance:

This equipment has been tested and found to comply with the limits for a digital device, pursuant to part 15 of the FCC Rules. This equipment generate, uses and can radiate radio frequency energy and, if not installed and used in accordance with the guide, may cause harmful interference to radio communication.





- For class A device, these limits are designed to provide reasonable protection against harmful interference in a commercial environment. Operation of this equipment in a residential area is likely to cause harmful interference in which case the user will be required to correct the interference at his own expense.
- For class B device, these limits are designed to provide reasonable protection against harmful interference in a residential installation. However, there is no guarantee that interference will not occur in a particular installation. If this equipment does cause harmful interference to radio or television reception, which can be determined by turning the equipment off and on, the user is encouraged to try to correct the interference by one or more of the following measures:
 - Reorient or relocate the receiving antenna.
 - Increase the separation between the equipment and receiver.
 - Connect the equipment into an outlet on a circuit different from that to which the receiver is connected.
 - Consult the dealer or an experienced radio/TV technician for help.

General

This document elaborates on structure, installation and wiring of four-door one-way access controller.

Safety Instructions

The following categorized signal words with defined meaning might appear in the Manual.

Signal Words	Meaning
 DANGER	Indicates a high potential hazard which, if not avoided, will result in death or serious injury.
 WARNING	Indicates a medium or low potential hazard which, if not avoided, could result in slight or moderate injury.
 CAUTION	Indicates a potential risk which, if not avoided, could result in property damage, data loss, lower performance, or unpredictable result.
 TIPS	Provides methods to help you solve a problem or save you time.
 NOTE	Provides additional information as the emphasis and supplement to the text.

Privacy Protection Notice

As the device user or data controller, you might collect personal data of others, such as face, fingerprints, car plate number, Email address, phone number, GPS and so on. You need to be in compliance with the local privacy protection laws and regulations to protect the legitimate rights and interests of other people by implementing measures, including but not limited to: providing clear and visible identification to inform data subject the existence of surveillance area and providing related contact.

About the Manual

- The Manual is for reference only. If there is inconsistency between the Manual and the actual product, the actual product shall prevail.
- We are not liable for any loss caused by the operations that do not comply with the Manual.
- The Manual would be updated according to the latest laws and regulations of related regions. For detailed information, see the paper User's Manual, CD-ROM, QR code or our official website. If there is inconsistency between paper User's Manual and the electronic version, the electronic version shall prevail.

- All the designs and software are subject to change without prior written notice. The product updates might cause some differences between the actual product and the Manual. Please contact the customer service for the latest program and supplementary documentation.
- There still might be deviation in technical data, functions and operations description, or errors in print. If there is any doubt or dispute, please refer to our final explanation.
- Upgrade the reader software or try other mainstream reader software if the Manual (in PDF format) cannot be opened.
- All trademarks, registered trademarks and the company names in the Manual are the properties of their respective owners.
- Please visit our website, contact the supplier or customer service if there is any problem occurred when using the device.
- If there is any uncertainty or controversy, please refer to our final explanation.

Important Safeguards and Warnings

The following description is the correct application method of the device. Please read the manual carefully before use, in order to prevent danger and property loss. Strictly conform to the manual during application and keep it properly after reading.

Operating Requirement

- Please don't place and install the device in an area exposed to direct sunlight or near heat generating device.
- Please don't install the device in a humid, dusty or fuliginous area.
- Please keep its horizontal installation, or install it at stable places, and prevent it from falling.
- Please don't drip or splash liquids onto the device; don't put on the device anything filled with liquids, in order to prevent liquids from flowing into the device.
- Please install the device at well-ventilated places; don't block its ventilation opening.
- Use the device only within rated input and output range.
- Please don't dismantle the device arbitrarily.
- Please transport, use and store the device within allowed humidity and temperature range.

Power Requirement

- Please make sure to use batteries according to requirements; otherwise, it may result in fire, explosion or burning risks of batteries!
- To replace batteries, only the same type of batteries can be used!
- The product shall use electric cables (power cables) recommended by this area, which shall be used within its rated specification!
- Please use standard power adapter matched with the device; otherwise, the resulting personal injury or device damage shall be borne by the user.
- Please use power supply that meets SELV (safety extra low voltage) requirements, and supply power with rated voltage that conforms to Limited Power Source in IEC60950-1. For specific power supply requirements, please refer to device labels.
- Products with category I structure shall be connected to grid power output socket, which is equipped with protective grounding.
- Appliance coupler is a disconnecting device. During normal use, please keep an angle that facilitates operation.

Table of Contents

Cybersecurity Recommendations	II
Regulatory Information	V
Foreword	VI
Important Safeguards and Warnings	VIII
1 Overview	1
1.1 Functional Feature	1
1.2 External Dimension	1
2 Installation Guide	3
2.1 System Structure.....	3
2.2 Device Installation.....	3
2.3 Wiring Diagram	5
2.3.1 Wiring Description of Access Controller	5
2.3.2 Wiring Description of Exit Button/Door Contact	5
2.3.3 Wiring Description of Lock.....	6
2.3.4 Wiring Description of Reader.....	8
2.3.5 Wiring Description of External Alarm Input.....	8
2.3.6 Wiring Description of Alarm Output	9
2.3.7 Description of Alarm Input and Output Rule.....	9
2.4 DIP Switch.....	10
2.5 Restart.....	11
3 SmartPSS Config	12
3.1 Login Client	12
3.2 Add Access Controller	12
3.2.1 Auto Search	12
3.2.2 Manual Add.....	14
3.3 Add User	16
3.3.1 Card Type	17
3.3.2 Single Add.....	18
3.4 Add Door Group	20
3.5 Authorize	22
3.5.1 Authorize According to Door Group.....	22
3.5.2 Authorize According to User	23
4 FAQ	25
1. Question: After power on, power indicator doesn't turn on or the buzzer doesn't respond.	25
2. Question: After the reader is connected with the device, card swiping light doesn't turn on, and it doesn't respond after swiping a card.	25
3. Question: Client software fails to detect the device.	25
4. Question: After swiping card, it prompts that card is invalid.....	25
5. Question: Default IP of access controller.	25
6. Question: Default port, initial user name and password of access controller.	25
7. Question: Online upgrade of the device.	25

8. Question: Max. wiring distance and transmission distance of card reader and controller.....	25
5 Technical Parameters.....	26

Four-door one-way access controller is a controlling device which compensates video surveillance and visual intercom. It has neat and modern design with strong functionality, suitable for commercial building, corporation property and intelligent community.

1.1 Functional Feature

Its rich functions are as follows:

- Professional industrial design, lock and hinge rotational structure, able to bear 80kg force, with excellent vandal-resistant performance.
- Integrate alarm, access control, video surveillance and fire alarm.
- Support 4 sets of card readers.
- Support 10 groups of signal input (exit button*4, door contact*4, intrusion alarm*1 and tamper alarm*1).
- Support 5 groups of control output (electric lock *4 and alarm output *1).
- With RS485 port, it may extend to connect control module.
- FLASH storage capacity is 16M. Support max. 100,000 card holders and 150,000 card reading records.
- Support tamper alarm, illegal intrusion alarm, unlock timeout alarm, duress card and duress code setup. Also support black-white list and patrol card setup.
- Support valid time period setting, password setting and expiration date setting of cards. Regarding guest card, its time of use can be set.
- Support 128 groups of schedules and 128 groups of holiday schedules.
- Permanent data storage during outage, built-in RTC (support DST), online upgrade.

1.2 External Dimension

Its appearance and dimension is shown in Figure 1-1. The unit is mm.

Figure 1-1

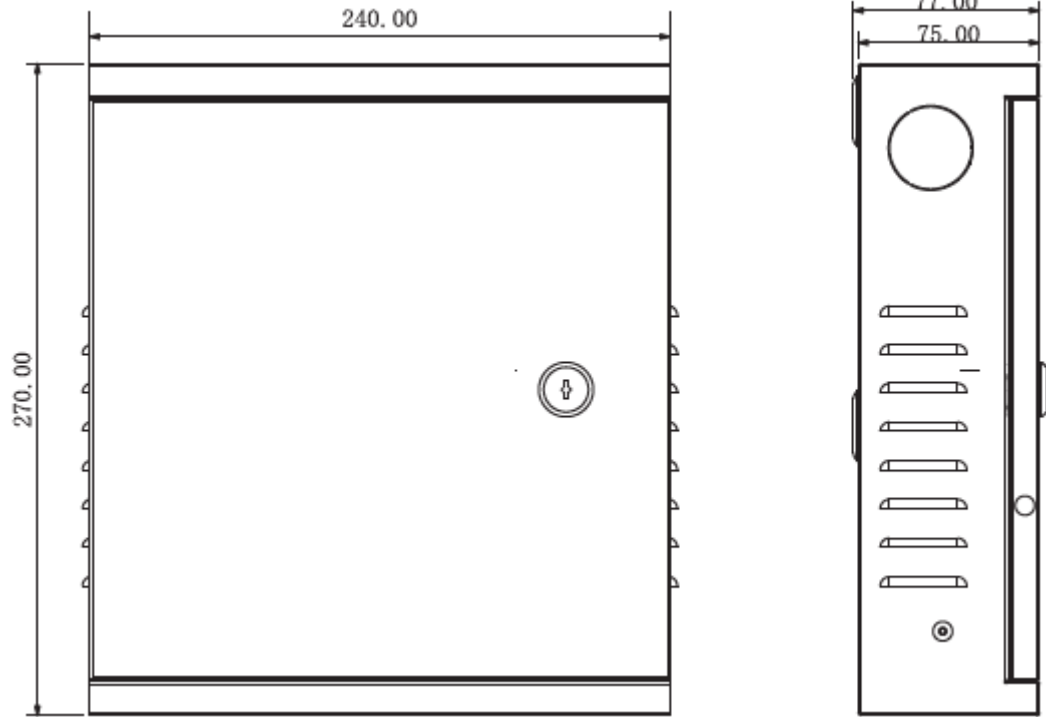

2

Installation Guide

2.1 System Structure

System structure of four-door one-way access controller, door lock and reader is shown in Figure 2-1.

Figure 2-1

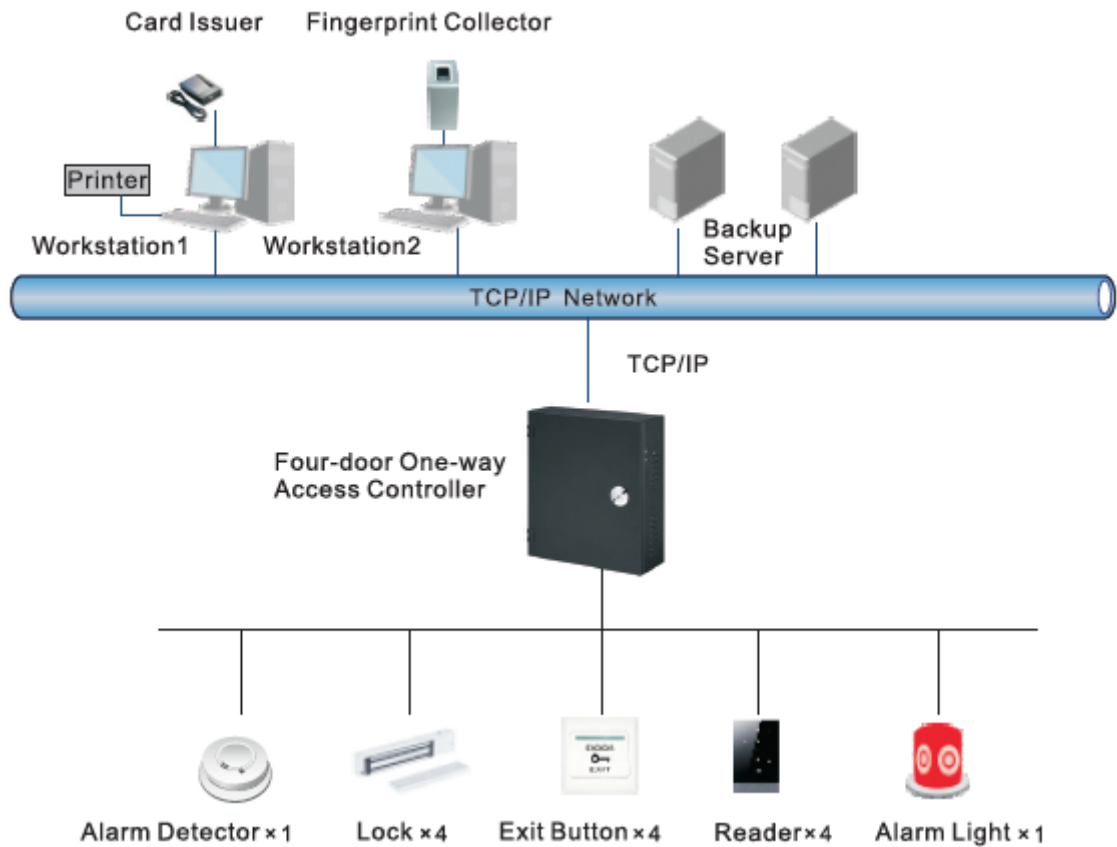

2.2 Device Installation

Device installation diagram is shown in Figure 2-2 and Figure 2-3. The unit is mm.

Figure 2-2

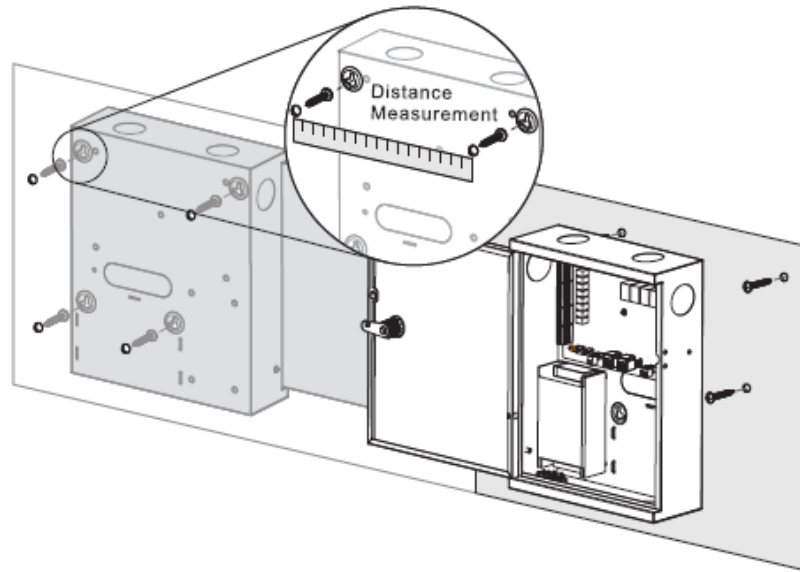
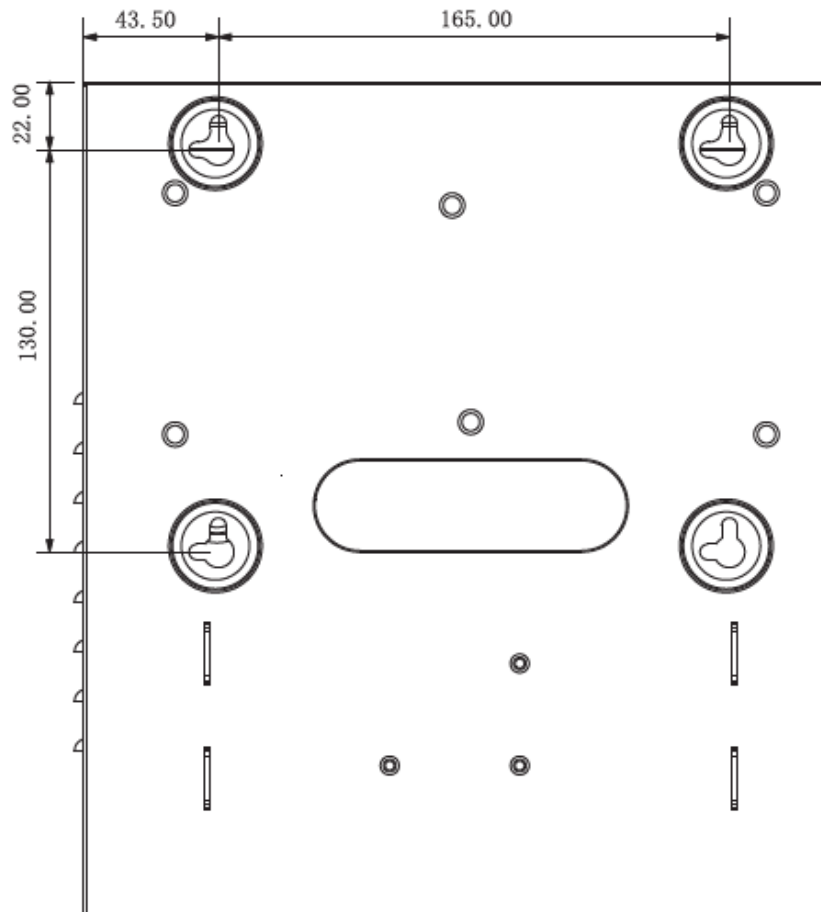

Figure 2-3



 **NOTE**

Please ensure that device mounting surface is able to bear 3 times as many as the total weight of the device, bracket and accessories.

Step 1 Measure every hole distance and position according to holes at rear shell of the device, as shown in Figure 2-3; drill holes in the wall according to the measured positions.

Step 2 Embed expansion nuts and fix screws into the wall.

Step 3 Hang the whole device onto the screws.

2.3 Wiring Diagram

2.3.1 Wiring Description of Access Controller

This device supports four-door in or out. In case of alarm input, trigger external alarm output device to give an alarm. Device wiring diagram is shown in Figure 2-4.

Figure 2-4

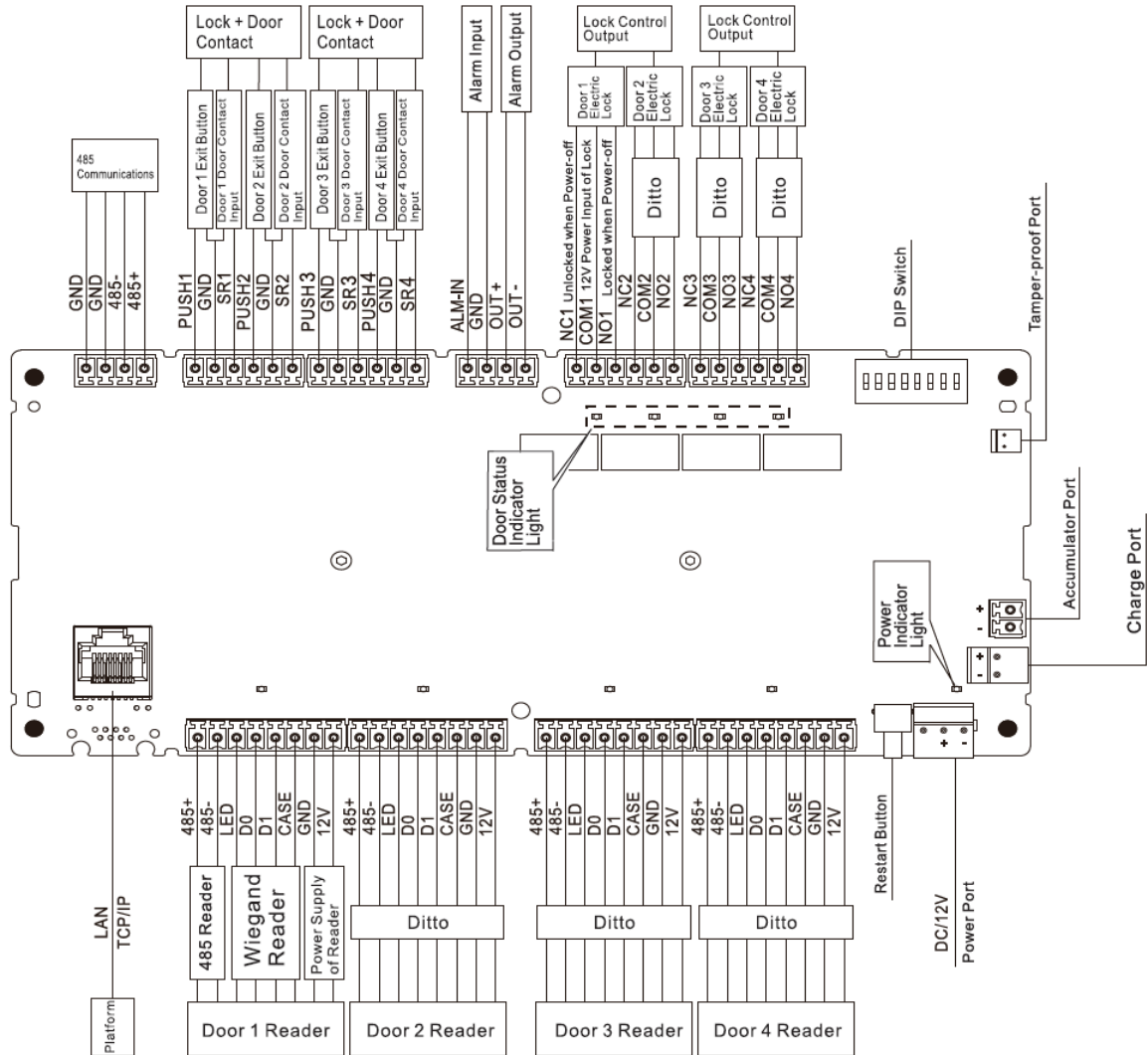

2.3.2 Wiring Description of Exit Button/Door Contact

Corresponding wiring terminals of exit button and door contact are shown in Figure 2-5. Please refer to Table 2-1 for descriptions of wiring terminals.

Figure 2-5

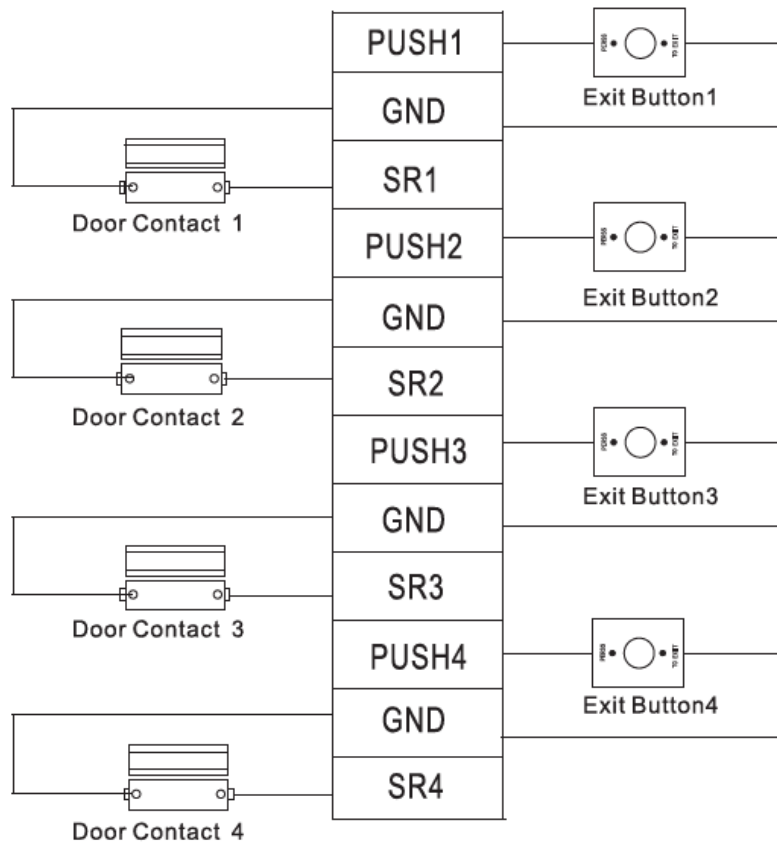

Table 2-1

Port	Wiring Terminal	Description
Exit button+ door contact	PUSH1	Exit button of door 1
	GND	Shared by exit button of door 1 and door contact input of door 1
	SR1	Door contact input of door 1
	PUSH2	Exit button of door 2
	GND	Shared by exit button of door 2 and door contact input of door 2
	SR2	Door contact input of door 2
	PUSH3	Exit button of door 3
	GND	Shared by exit button of door 3 and door contact input of door 3
	SR3	Door contact input of door 3
	PUSH4	Exit button of door 4
	GND	Shared by exit button of door 4 and door contact input of door 4
	SR4	Door contact input of door 4

2.3.3 Wiring Description of Lock

Support 4 groups of lock control outputs; serial numbers after the terminals represent corresponding doors. Please choose a proper connection mode according to lock type, as

shown in Figure 2-6, Figure 2-7 and Figure 2-8. Please refer to Table 2-2 for descriptions of wiring terminals.

Figure 2-6

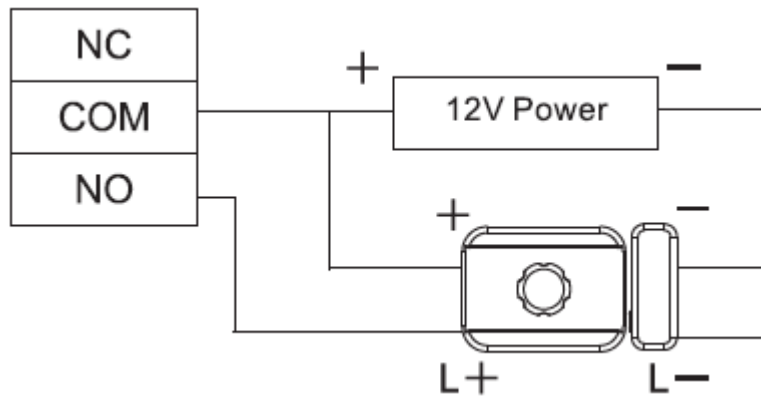

Figure 2-7

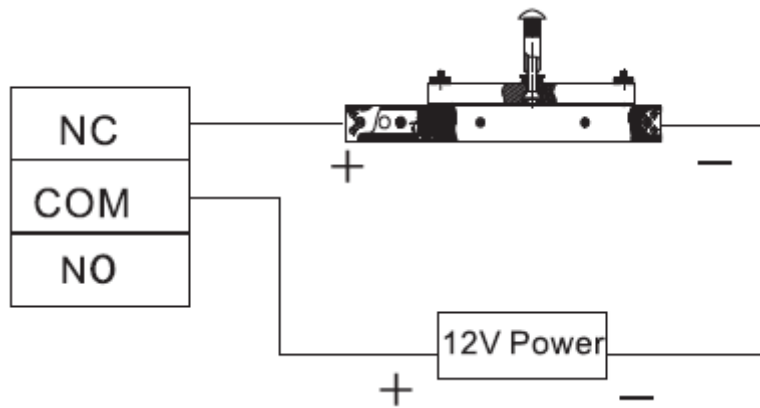

Figure 2-8

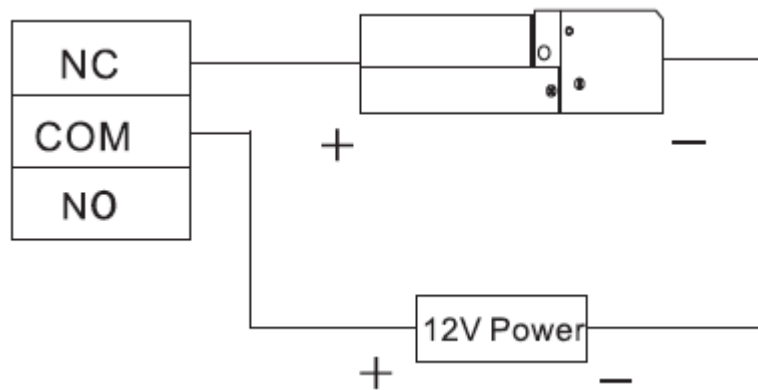

Table 2-2

Port	Wiring Terminal	Description
Lock control output port	NC1	Lock control of door 1
	COM1	
	NO1	
	NC2	Lock control of door 2
	COM2	
	NO2	
Lock control output port	NC3	Lock control of door 3
	COM3	

Port	Wiring Terminal	Description
	NO3	Lock control of door 4
	NC4	
	COM4	
	NO4	

2.3.4 Wiring Description of Reader

NOTE

1 door only supports to connect one type of reader—485 or Wiegand.

Please refer to Table 2-3 for descriptions of wiring terminals corresponding to readers. Take door 1 for example; other readers are the same. Please refer to Table 2-4 for descriptions of reader cable specification and length.

Table 2-3

Port	Wiring Terminal	Cable Color	Description
Entry Reader of Door 1	485+	Purple	485 reader
	485-	Yellow	
	LED	Brown	Wiegand reader
	D0	Green	
	D1	White	
	CASE	Blue	
	GND	Black	Reader power supply
	12V	Red	

Table 2-4

Reader Type	Connection Mode	Length
485 Reader	CAT5e network cable, 485 connection	100m
Wiegand Reader	CAT5e network cable, Wiegand connection	100m

2.3.5 Wiring Description of External Alarm Input

External alarm input connection is shown in Figure 2-9. Please refer to Table 2-5 for descriptions of wiring terminals.

Figure 2-9

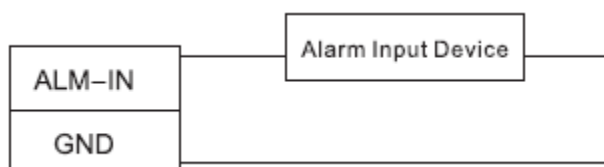



Table 2-5

Port	Wiring Terminal	Description
External alarm	ALM-IN	External alarm input ports are able to connect smoke

Port	Wiring Terminal	Description
input	GND	detector and IR detector etc..  NOTE When external alarm is triggered, all doors are linked to be normally open.

2.3.6 Wiring Description of Alarm Output

With 1-ch alarm output, after internal alarm input (such as door timeout) or external alarm input triggers an alarm, the alarm output device gives an alarm for 15s.

There are two connection modes of alarm output, depending on alarm device. For example, IPC can use Mode 1, whereas audible and visual siren can use Mode 2, as shown in Figure 2-10 and Figure 2-11. Please refer to Table 2-6 for descriptions about wiring terminals.

Figure 2-10

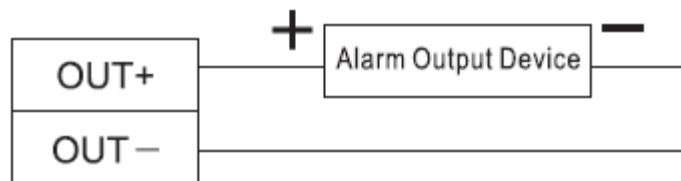

Figure 2-11

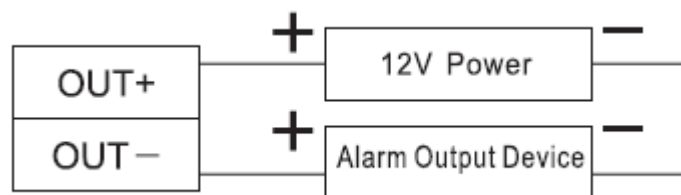

Table 2-6

Port	Wiring Terminal	Description
Alarm output	OUT1+	<ul style="list-style-type: none"> ALM-IN triggers alarm output. Door timeout and intrusion alarm output. Tamper alarm output of reader
	OUT1-	

2.3.7 Description of Alarm Input and Output Rule

In case of alarm event, access controller can control the access and external alarm status.

Please refer to Table 2-7 for detailed alarm input and output rules.

Table 2-7

Alarm Type	Alarm Event	Alarm Signal Input Port	Alarm Signal Output Port	Alarm Status
External alarm input	Trigger no. 1 alarm detector	ALM1	OUT1	No. 1 alarm gives an alarm, and links all doors to



Alarm Type	Alarm Event	Alarm Signal Input Port	Alarm Signal Output Port	Alarm Status
				be normally open.
Internal alarm input	Intrusion alarm or unlock timeout alarm of no. 1 door	SR1	OUT1	No. 1 alarm gives an alarm.
	Intrusion alarm or unlock timeout alarm of no. 2 door	SR2		
	Intrusion alarm or unlock timeout alarm of no. 3 door	SR3		
	Intrusion alarm or unlock timeout alarm of no. 4 door	SR4		
	Tamper alarm of no. 1 door reader	RS-485/CASE		
	Tamper alarm of no. 2 door reader	RS-485/CASE		
	Tamper alarm of no. 3 door reader	RS-485/CASE		
	Tamper alarm of no. 4 door reader	RS-485/CASE		

2.4 DIP Switch

Operate with DIP switch.

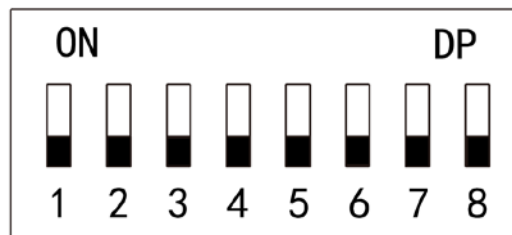
Figure 2-12



-  the switch is at ON position, meaning 1.
-  the switch is at the bottom, meaning 0.
- 1~8 are all 0; the system is started normally.
- 1~8 are all 1; the system enters BOOT mode after start.
- 1, 3, 5 and 7 are 1, while others are 0. After restart, the system restores factory defaults.
- 2, 4, 6 and 8 are 1, while others are 0. After restart, the system restores factory defaults, but user info is retained.

2.5 Restart

Press restart button (as shown in Figure 2-4 to restart the device.

 NOTE

Restart button is to restart the device, rather than modifying configuration.

3

SmartPSS Config

Access controller is managed with Smart PSS client, so as to realize control and right configuration of one door and door groups.

This chapter mainly introduces quick configuration. For specific operations, please refer to User's Manual of Smart PSS Client.

 NOTE

Smart PSS client offers different interfaces for different versions. Please refer to actual interface.

3.1 Login Client

Install the matching Smart PSS client, and double click  to run. Carry out initialization configuration according to interface prompts and complete login.

3.2 Add Access Controller

Add access controller in Smart PSS; select “Auto Search” and “Add”.

3.2.1 Auto Search

Devices are required to be in the same network segment.

Step 1 In “Devices” interface, click “Auto Search”, as shown in Figure 3-1.

The system displays “Auto Search” interface, as shown in Figure 3-2.

Figure 3-1

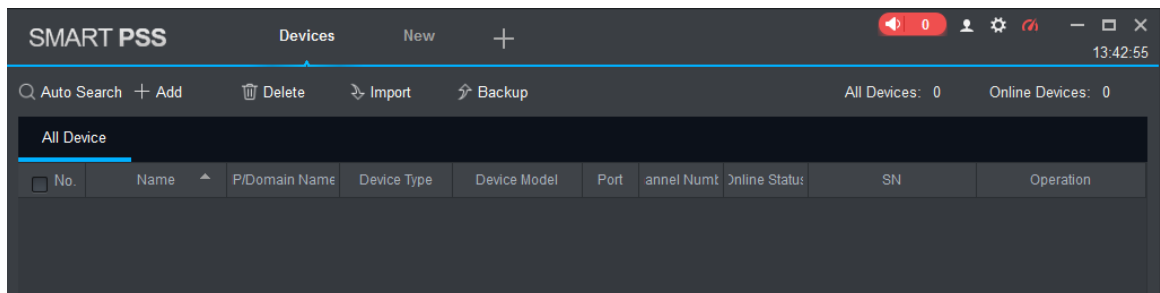
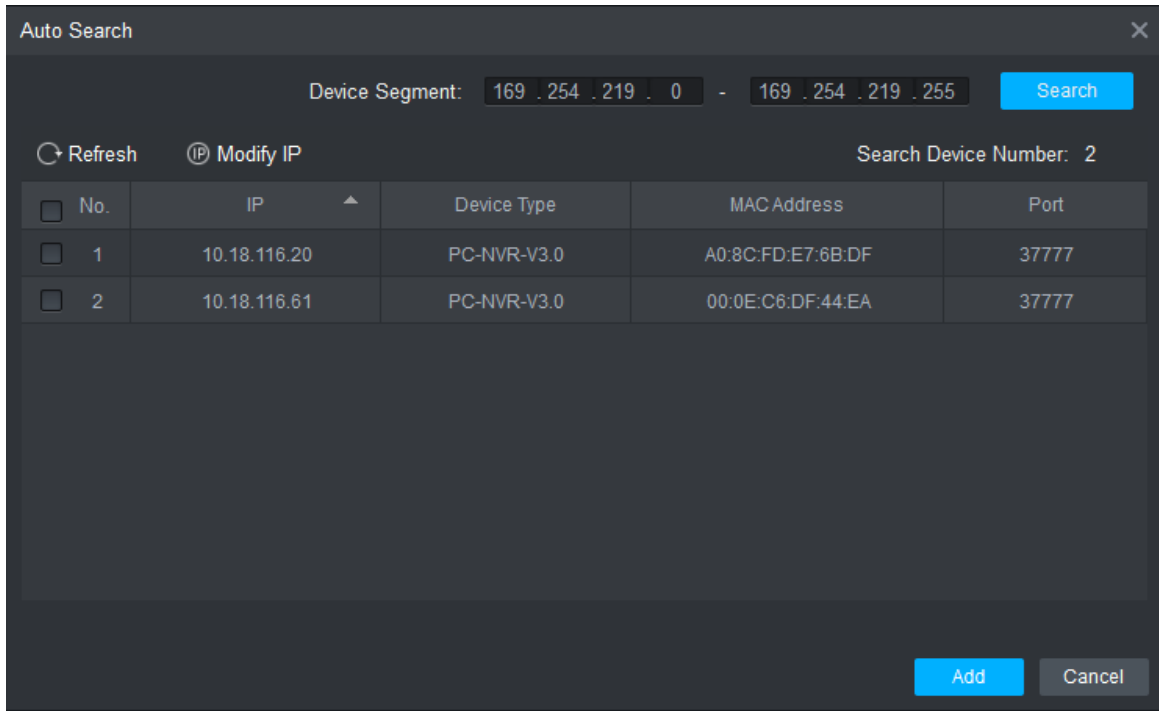

Figure 3-2



Step 2 Input device segment and click “Search”.

The system displays search results.

 NOTE

- Click “Refresh” to update device information.
- Select a device, click “Modify IP” to modify IP address of the device. For specific operations, please refer to User’s Manual of Smart PSS Client.

Step 3 Select the device that needs to be added, and click “Add”.

The system pops up “Prompt”.

Step 4 Click “OK”.

The system displays “Login Information” dialogue box, as shown in Figure 3-3.

Figure 3-3

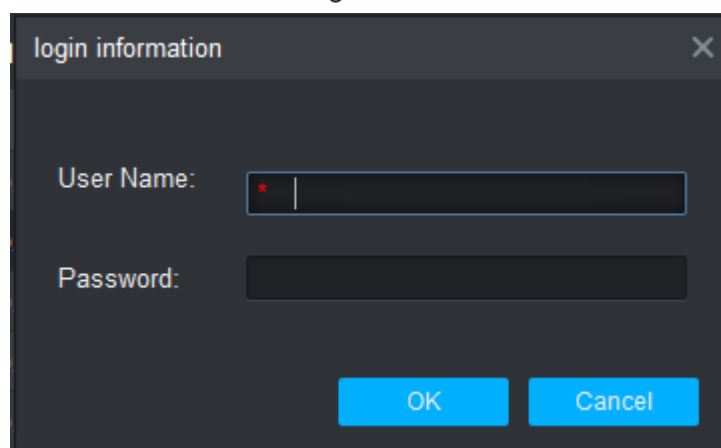

Step 5 Input “User Name” and “Password” to log in the device, and click “OK”.

The system displays the added device list, as shown in Figure 3-4. Please refer to Table 3-1 for details.

 NOTE

- After completing adding, the system continues to stay at “Auto Search” interface. You can continue to add more devices, or click “Cancel” to exit “Auto Search”

interface.

- After completing adding, Smart PSS logs in the device automatically. In case of successful login, online status displays “Online”. Otherwise, it displays “Offline”.

Figure 3-4

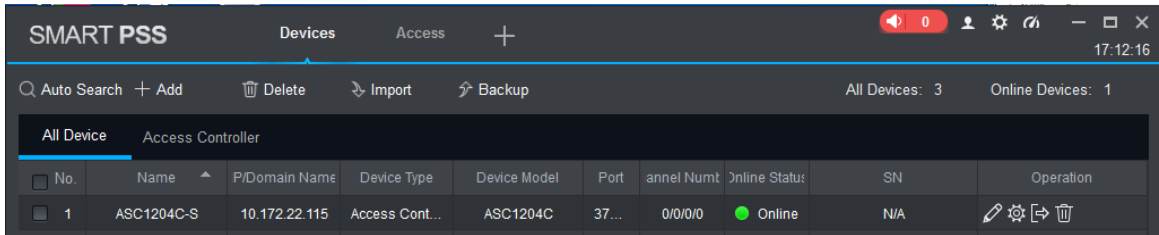

Table 3-1

Icon	Description
	Click this icon to enter “Modify Device” interface and modify device info, including device name, IP/domain name, port, user name and password. Alternatively, double click the device to enter “Modify Device” interface.
	Click this icon to enter “Device Config” interface and configure device camera, network, event, storage and system info.
and	<ul style="list-style-type: none"> • When the device is online, the icon is . Click this icon to exit login, and this icon turns to . • When the device is offline, the icon is . Click this icon to login (with correct device info), and this icon turns to .
	Click this icon to delete the device.

3.2.2 Manual Add

To add devices, device IP address or domain name shall be known first.

Step 1 In “Devices” interface, click “Add”, as shown in Figure 3-5.

The system pops up “Manual Add” interface, as shown in Figure 3-6.

Figure 3-5

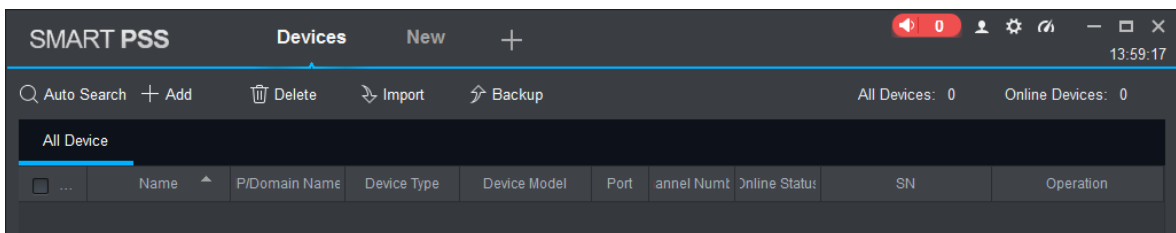

Figure 3-6

Step 2 Set device parameters. For specific parameter descriptions, please refer to Table 3-2.

Table 3-2

Parameter	Description
Device Name	It is suggested that device should be named by the monitoring zone, so as to facilitate maintenance.
Method to add	Select “IP/Domain Name”. Add devices according to device IP address or domain name.
IP/Domain Name	IP address or domain name of the device.
Port	Port number of the device. Default port number is 37777. Please fill in according to actual conditions.
Group Name	Select the group of the device.
User Name and Password	User name and password of the device.

Step 3 Click “Add” to add a device.

The system displays the added device list, as shown in Figure 3-4. Please refer to Table 3-1 for operation interface. Doors of the added controller are displayed under “Access” tab, as shown in Figure 3-7.

NOTE

- To add more devices, click “Save and Continue”, add devices and stay at “Manual Add” interface.
- To cancel the adding, click “Cancel” and exit “Manual Add” interface.
- After completing adding, Smart PSS logs in the device automatically. In case of successful login, online status displays “Online”. Otherwise, it displays “Offline”.

Figure 3-7

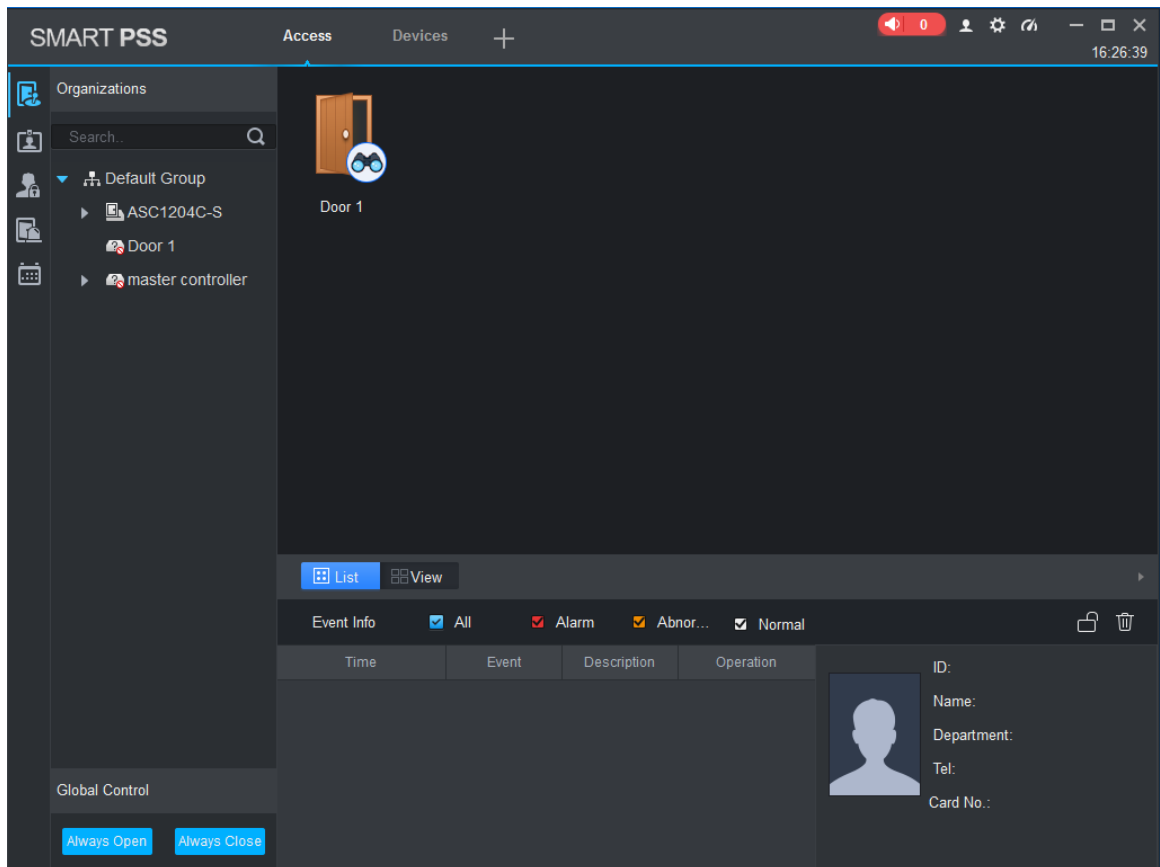

3.3 Add User

Add users and bind with cards, so as to distribute authority.

In “New” interface, click “Access” to enter “Access” interface, and complete access config here.

Figure 3-8

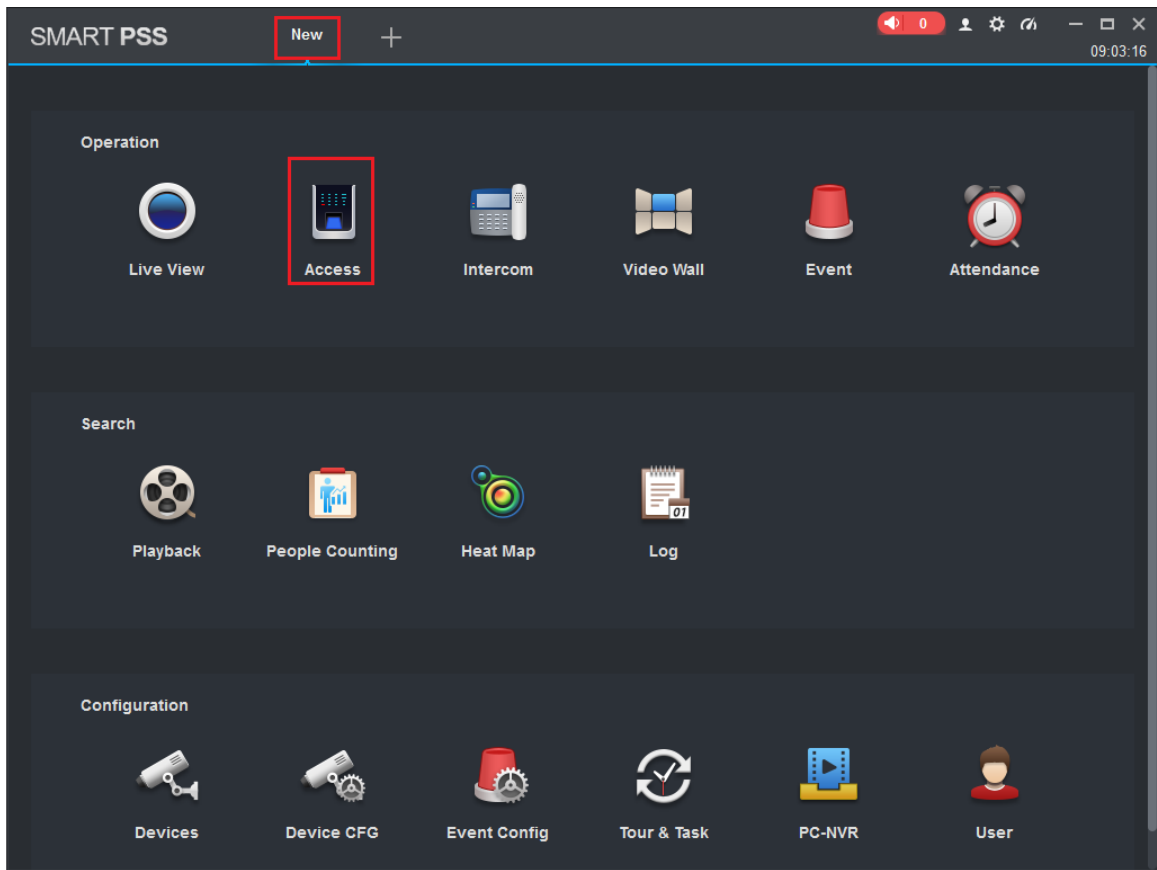

3.3.1 Card Type

CAUTION

Card type shall be the same with card issuer; otherwise, it fails to read card number.

In “Access” interface, click  and then click  to set the card type, as shown in Figure 3-9 and Figure 3-10.

Figure 3-9

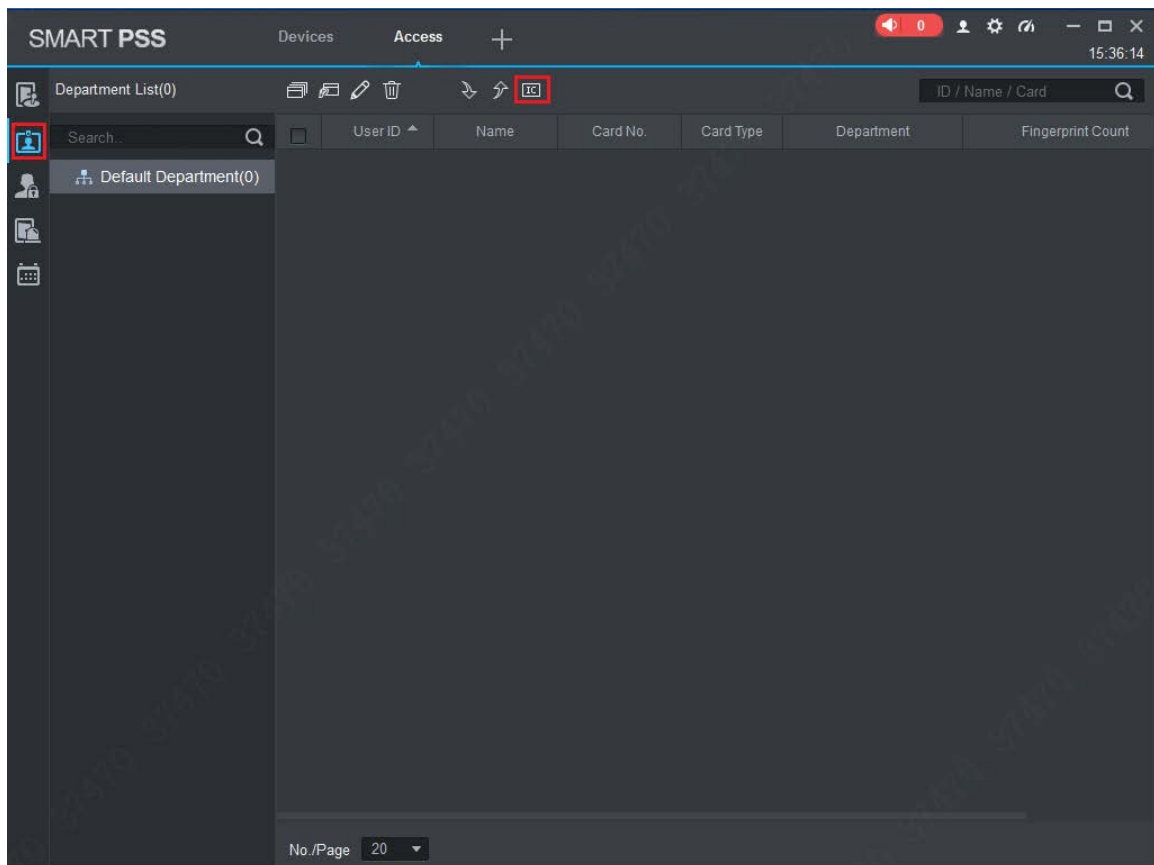
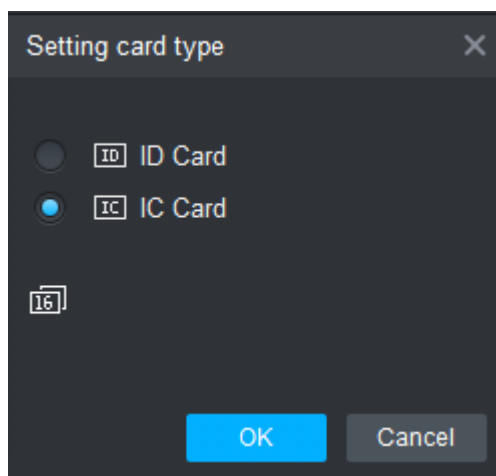

Figure 3-10



3.3.2 Single Add

Add a single user, send a card and input user info.



Step 1 In "Access" interface, click , and then click , as shown in Figure 3-11. The system pops up "Add User" dialog box, as shown in Figure 3-12.

Figure 3-11

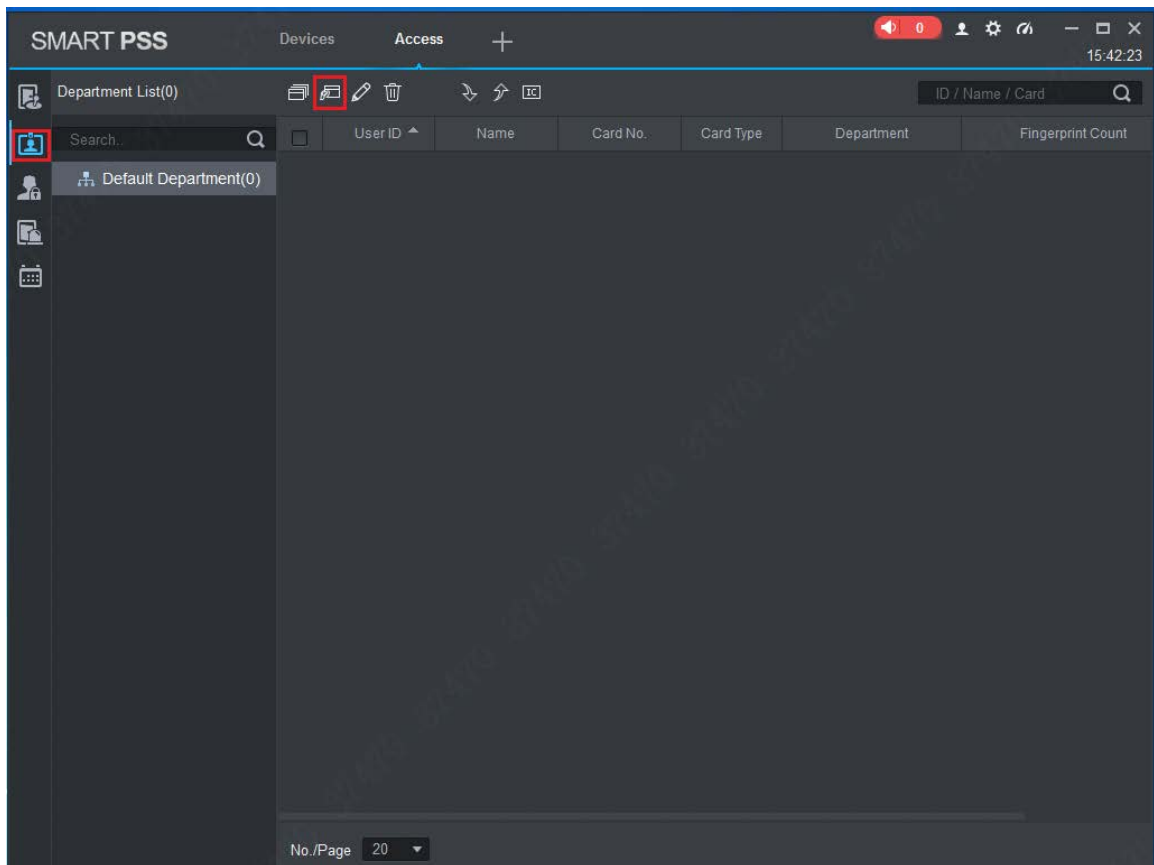
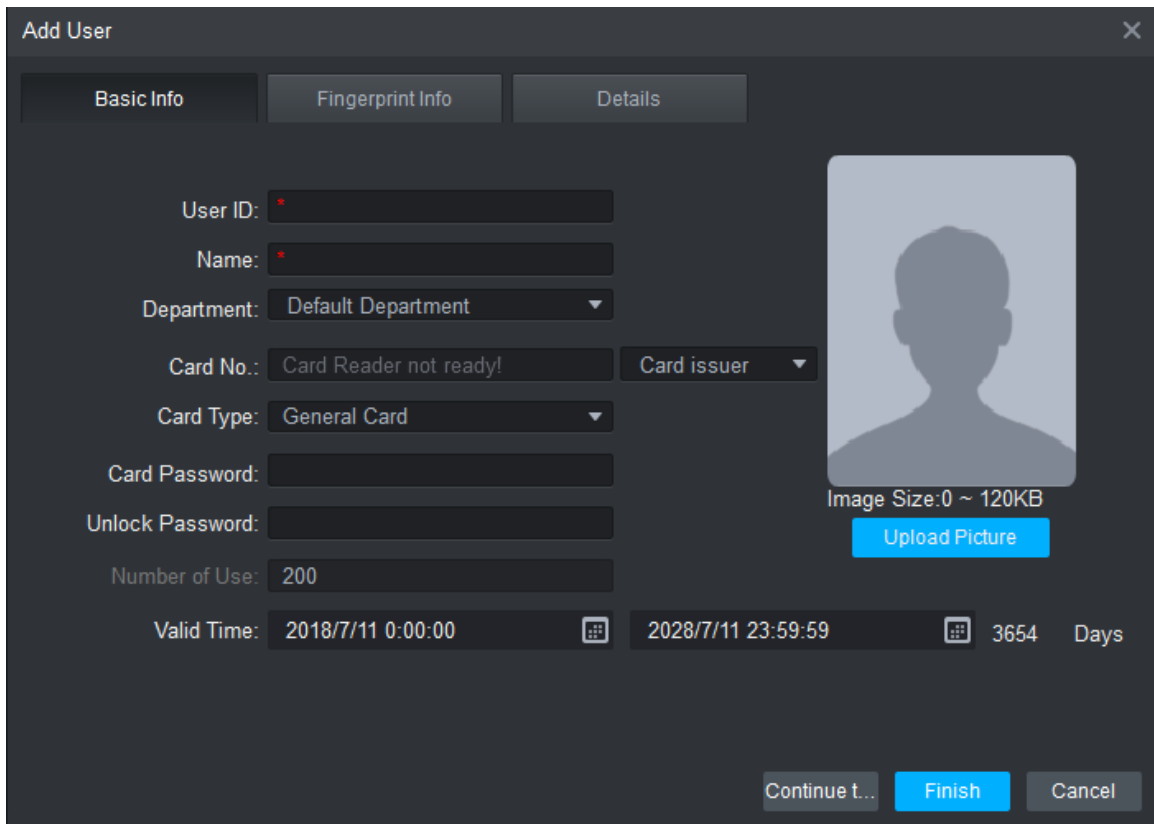



Figure 3-12



Step 2 Add user info manually, including basic info, fingerprint info and details. Please refer to Table 3-3 for details.

Table 3-3

Parameter	Description
Basic Info	<ul style="list-style-type: none"> ● User ID (mandatory). ● Name (mandatory). ● Department (auto association). ● Card No.: input by card reader or input manually. ● Card type: general card, VIP card, guest card, patrol card, blacklist card and duress card. ● Card Password: it is used to open the door with card + password. ● Unlock Password: it is used to open the door with password. ● Number of Use: it only applies to guest card. ● Valid Time: set the valid time of card, which is 10 years by default. ● Picture: user picture, max. 120K. <p> NOTE Card no. and user ID cannot be repeated.</p>
Fingerprint Info	<p>Collect fingerprints with fingerprint reader and access reader.</p> <ul style="list-style-type: none"> ● Max. 2 fingerprints for every person. ● Support to enter fingerprint name.
Details	Fill in detailed user info according to interface parameters.

Step 3 Click “Finish” to finish adding the users.

3.4 Add Door Group

Divide doors into groups and manage them together.

Step 1 In “Access” interface, click , and then click “Access Level”, as shown in Figure 3-13.

Figure 3-13



Step 2 Click “Add”.

The system pops up “Add Door Group” dialog box, as shown in Figure 3-14.

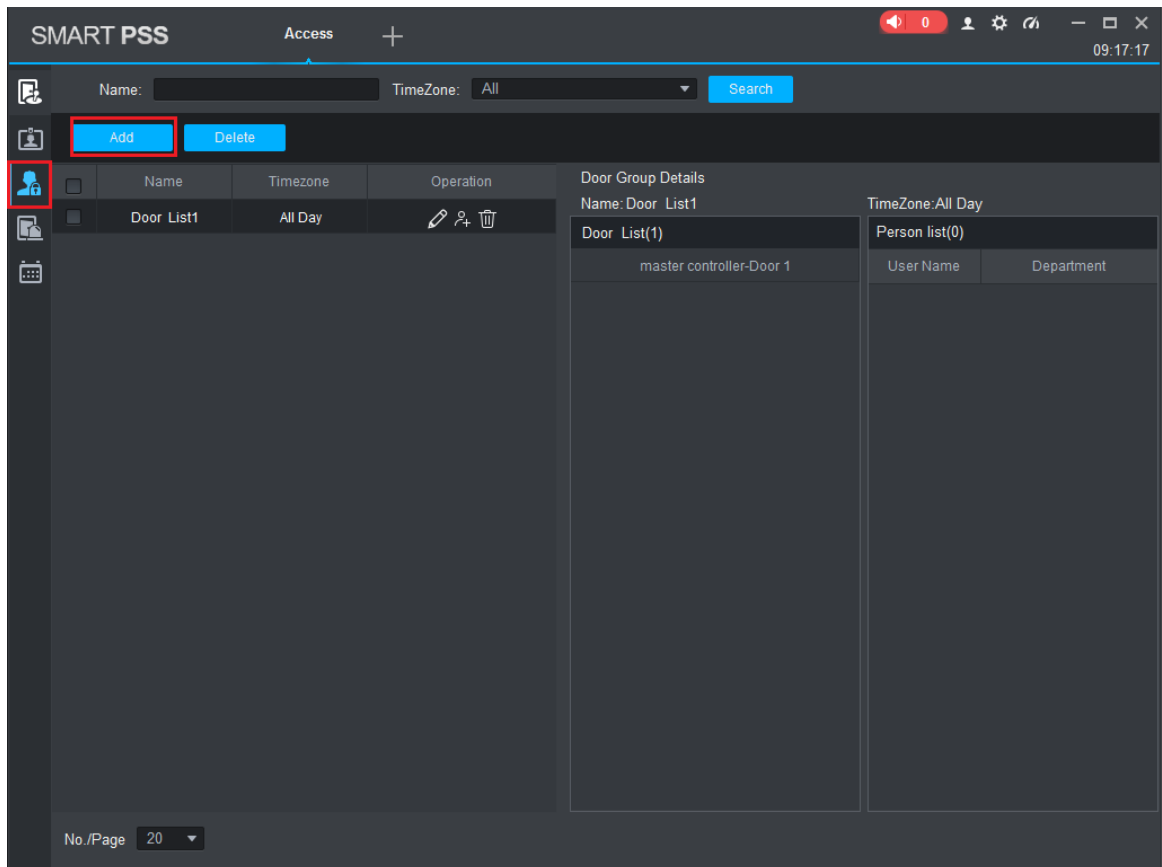
Figure 3-14

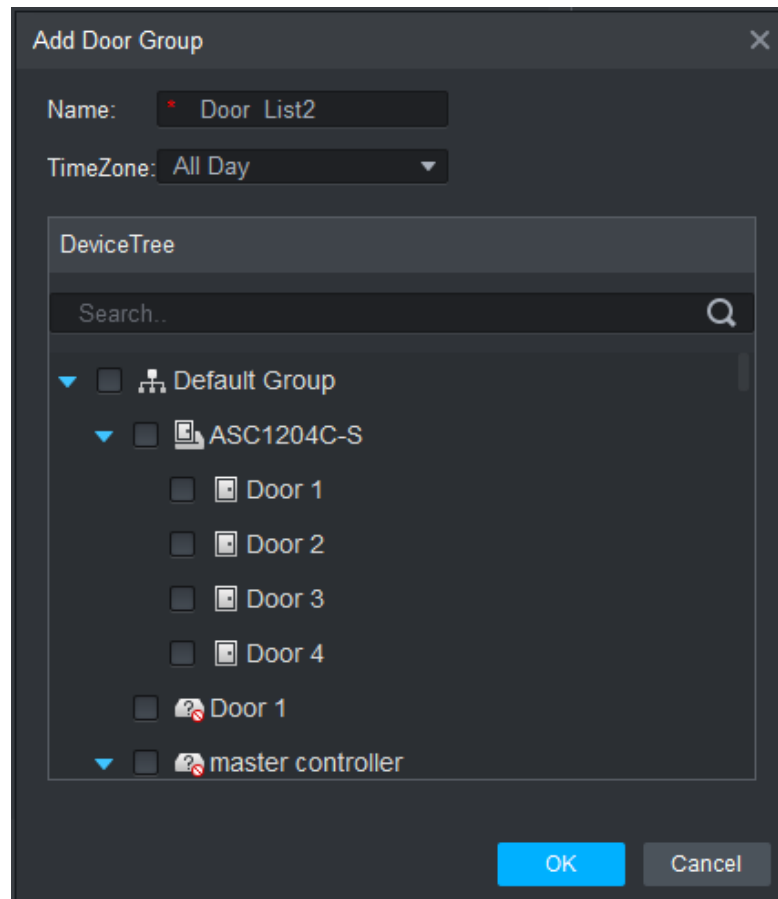

Step 3 Enter “Name”; select “Time Zone” and doors to be managed.

Step 4 Click “OK” to complete adding.

3.5 Authorize

Grant users authorities according to door group and user.

3.5.1 Authorize According to Door Group

Select a door group, add corresponding users to the group, so all users in the group obtain authority of all doors in the group.

Step 1 In “Access” interface, click , and then click “Access Level”, as shown in Figure 3-15.

Figure 3-15



Step 2 Click .

The system pops up “User Select” dialog box.

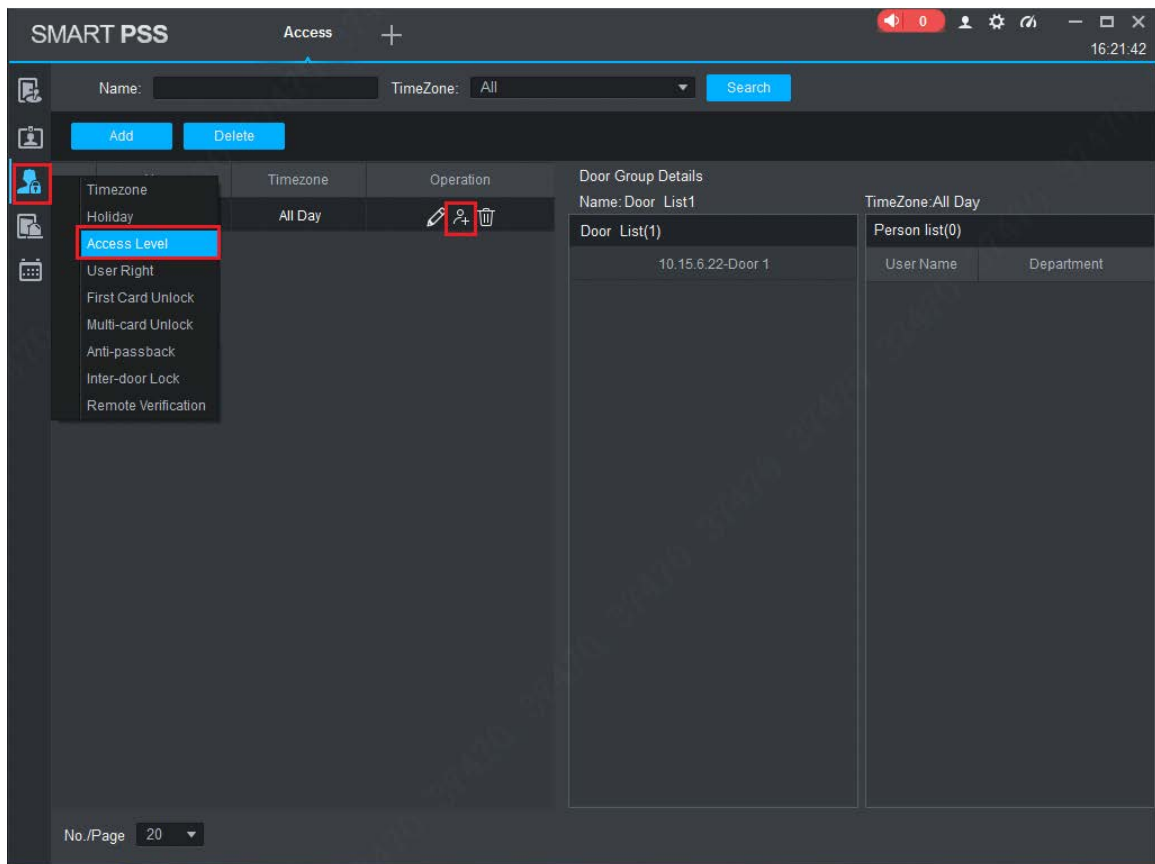
Step 3 Select the user’s department from dropdown list, or enter the user’s ID or name directly, as shown in Figure 3-16.

Figure 3-16

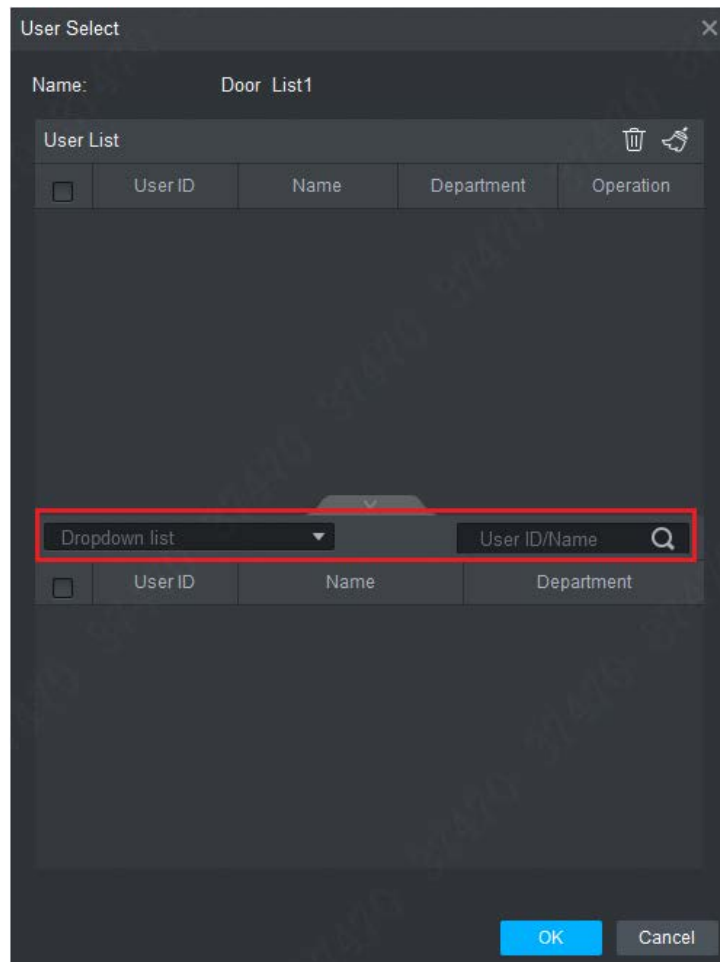

Step 4 In the search list, select the user and add to user list.

Step 5 Click “OK” to finish authorization.

 **NOTE**

- The search list filters user info without card number.
- In the user list, cancel the added user and delete the user’s authority.

3.5.2 Authorize According to User

Select a user, distribute door group and grant door group authority to the user.



Step 1 In “Access” interface, click , and then click “User Right”, as shown in Figure 3-17.

Figure 3-17

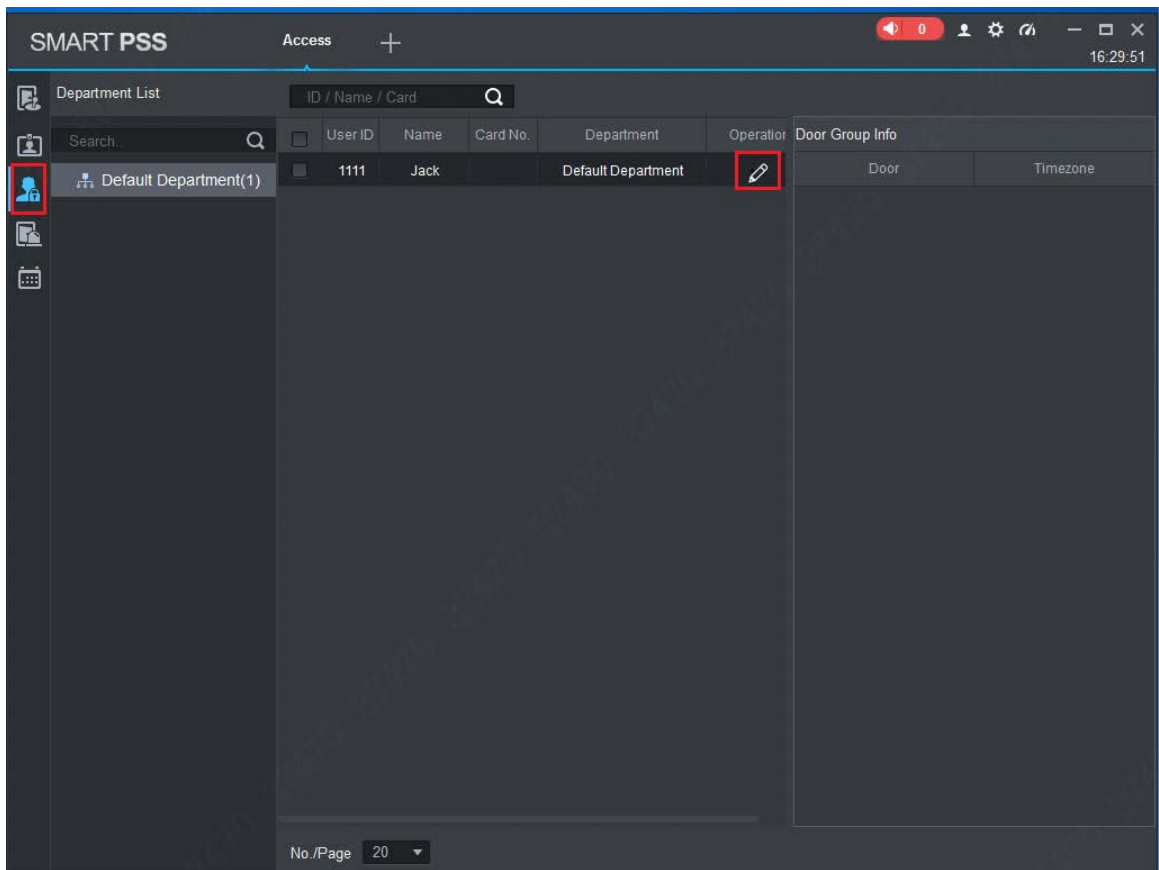

Step 2 Click .

The system pops up “Select Door Group” dialog box, as shown in Figure 3-18.

Figure 3-18

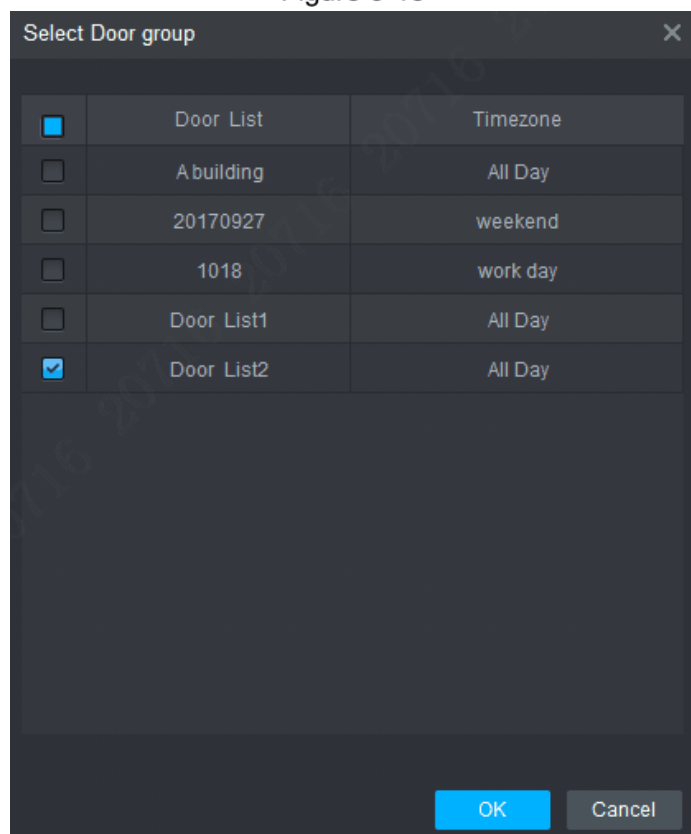

Step 3 Select the door group and click “OK” to finish authorization.

For problems not included hereinafter, please contact local customer service personnel or consult headquarter customer service personnel. We will be always at your service.

1. Question: After power on, power indicator doesn't turn on or the buzzer doesn't respond.

Answer: Please check whether power plug is inserted in place. Please pull it out and insert it again.

2. Question: After the reader is connected with the device, card swiping light doesn't turn on, and it doesn't respond after swiping a card.

Answer: Please check whether reader connector is inserted in place. Please pull it out and insert it again; check whether reader contact light turns on.

3. Question: Client software fails to detect the device.

Answer: Please check whether TCP/IP connector is connected properly, and whether device IP is in the same network segment.

4. Question: After swiping card, it prompts that card is invalid.

Answer: Please check whether this card number has been added in the controller.

5. Question: Default IP of access controller.

Answer: Default IP address is 192.168.0.2.

6. Question: Default port, initial user name and password of access controller.

Answer: Default port is 37777, initial user name is admin and password is 123456.

7. Question: Online upgrade of the device.

Answer: Connect the device and platform through network, and upgrade it at the platform.

8. Question: Max. wiring distance and transmission distance of card reader and controller.

Answer: It depends on network cable type and whether it needs power supply of control relay.

Connected with CAT5E network cable, typical value is:

- RS485, 100m.
- Wiegand, 100m.

5

Technical Parameters

Parameter	Specification
Processor	32-bit ARM processor
Memory capacity	16M
Max. number of user	100,000
Max. storage record	150,000
Communication port of reader	Wiegand, RS485
Communication port of platform	TCP/IP
Number of connected reader	4 groups
Working power supply	Rated voltage 10V-15V DC, rated current 0.75A
Period	128
Holiday	128
Unlocking mode	Card, card + password, password, card or password, card + fingerprint, fingerprint + password, fingerprint or card or password, by period
Cross-segment networking	Support
Two-door interlocking	Support
Real-time surveillance	Support
Fire alarm linkage	Support
Tamper alarm	Support
Intrusion alarm	Support
Unlock timeout alarm	Support
Duress card and code setting	Support
DST and RTC	Support
Online upgrade	Support